

DORO®

Cranial Stabilization & Retractor Systems





*„Every product we build represents
the commitment of our team
to put the needs and benefit
of the people we serve first.“*

Matthias Schüle
PMI Managing Director

CONTENTS

Rigid & Non-invasive Headrest Systems

DORO® QR3 Headrest System Aluminum	page 4
DORO® QR3 Skull Clamp	page 5
DORO® Aluminum Adaptors and Base Units	page 6
DORO® Base Unit and Parkbench	page 7
DORO® Aluminum Table Adaptors	page 7
DORO® QR3 Headrest System Teflon®	page 8
DORO® QR3 Skull Clamp Teflon®	page 9
DORO® Multi-Purpose Skull Clamp	page 10
DORO® Easy Connect Navigation Adaptors	page 13
DORO® Accessories	page 13
DORO® Skull Pins	page 14
DORO® Aluminum Horseshoe Headrests	page 15

Imaging Solutions

DORO LUCENT® Headrest System	page 16
DORO® Skull Clamp Radiolucent	page 18
DORO LUCENT® Accessories	page 19
DORO® Radiolucent Table Adaptors	page 19
DORO® Mix & Match	page 20
DORO® Radiolucent Horseshoe Headrests	page 22
DORO LUCENT® Horseshoe Headrest ENT	page 23
DORO® Navigation Adaptors Radiolucent	page 23
DORO LUCENT® iMRI Headrest Systems	page 24
DORO LUCENT® iMRI HRS Systems Training	page 26
DORO® Skull Clamp for Spinal Frames	page 27

Halo & Retractor Systems

DORO LUNA® Retractor System	page 28
DORO COBRA® Quick-Clamps	page 30
DORO COBRA® Flexible Rotary Arms	page 32
DORO® Flexible Arms	page 32
DORO® Quick-Clamp with Starburst	page 33
DORO® Halo Brain Retractor System	page 34
DORO® Quick-Clamp & Retractor Accessories	page 35
DORO® Blades	page 36
DORO® Micro Blades	page 37
DORO® Sterilization Trays	page 37



DORO® QR3 Headrest System



DORO® QR3 Headrest System
(shown with DORO® Skull Pins)
Item no. 1001.100

Description	Item no.
DORO® QR3 Skull Clamp	1001.001
DORO® Swivel Adaptor Aluminum	3002-00
DORO® Base Unit Aluminum	3001-00

^Δ Sitting positions: Only in conjunction with the DORO® Crossbar Adaptor (shown on page 13).

^Δ Lateral position: In conjunction with the DORO® Parkbench Base Unit (shown on page 7).

^{ΔΔ} Interchangeability is only provided when using the corresponding accessories (shown on page 21).

^{ΔΔΔ} DORO® Easy Connect Navigation Adaptors are shown on page 13.

Skull Pins are not included in the DORO® QR3 Headrest System or DORO® QR3 Skull Clamp.

Key Features

- Highest quality workmanship and material selection.
- Excellent stability and flexibility.
- QR3 Quick-Rail® technology for quick connection of the DORO LUNA® Retractor System, DORO COBRA® Quick-Clamps or other accessories.
- For supine, prone, lateral and sitting positions.^Δ
- DORO® Mix & Match - interchangeable with DORO® Radiolucent Base Units and Adaptors.^{ΔΔ}
- Navigation Ready for Stryker®, Brainlab and Medtronic.^{ΔΔΔ}

DORO® QR3 Skull Clamp

The DORO® QR3 Skull Clamp provides 3-pin rigid cranial fixation. The improved Quick-Rail® makes it easy to connect accessories, even over multiple layers of sterile drape. State-of-the-art engineering makes it possible to build this 3rd generation Quick-Rail® skull clamp more stable than all its predecessors.

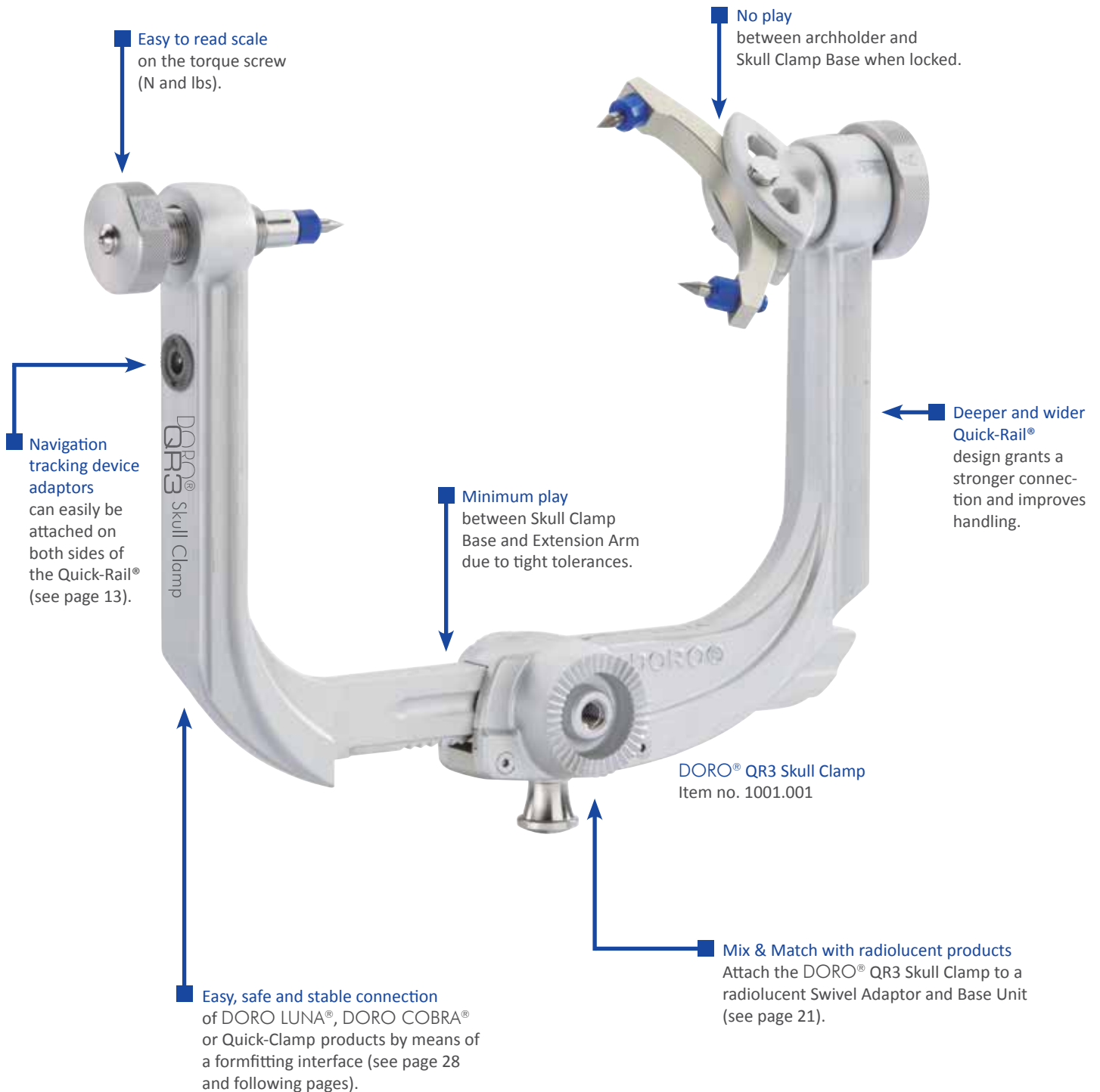

DORO® Aluminum Adaptors

High quality aluminum adaptors to connect DORO® Aluminum Skull Clamps and Horseshoes to the Base Unit.



DORO® Swivel Adaptor
Item no. 3002-00

- Provides 360° rotation for optimum flexibility in patient positioning.



DORO® Ball Pivot Adaptor
Item no. 3002-50

- Provides 360° rotation and pivoting.
- Provides additional height.
- Unique horizontal inclination up to 90° for maximum flexibility in patient positioning.



DORO® Swivel Adaptor Navigation
Item no. 3002-60

- Provides 360° rotation for optimum flexibility in patient positioning.
- Two additional starbursts for increased options in mounting navigational or similar devices.

DORO® Aluminum Base Units

Largest selection of base units. Easy to install in OR table rod slots. Excellent stability and durability.



DORO® Adjustable Base Unit
Item no. 3001-00



**DORO® Adjustable Base Unit
Takara Belmont**
Item no. 3001-001



**DORO® Adjustable Base Unit
Mizuho** | **Mizuho, short**
Item no. 3001-002 | Item no. 1001.023



**DORO® Adjustable Base Unit
Eschmann**
Item no. 3001-003



**DORO® Adjustable Base Unit
Eschmann T-Series**
Item no. 3001-010



**DORO® Adjustable Base Unit
Australia**
Item no. 3001-008

DORO® Base Unit Parkbench

Provides additional space for positioning the patient's arm comfortably and safely.

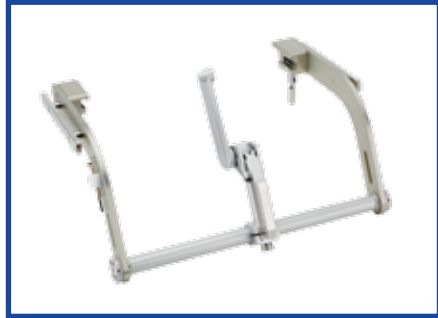

DORO® Base Unit Parkbench
Item no. 3001-006



Stryker Armrest Parkbench
Item no. 3001-007



Trumpf Universal Side Rail Fitting
Item no. 3007-50

- Connects the Armrest Parkbench to the DORO® Base Unit Parkbench.

Key Features

- The patient's arm can be positioned comfortably and safely.
- For prone, supine and especially useful for lateral positioning.
- Ideal for OR tables without traditional two rod slots.
- Unit may slide under OR table for prone and supine position. Built-in side rails on both arms return the functionality of the original OR table side rails.
- Easy to set-up with one self-locking lever for maximum stability.
- Adjustable in width.



DORO® Aluminum OR Table Adaptors



DORO® Table Adaptor
Mounted on square receptacle of OR table.
Item no. 3010-00



DORO® Side Rail OR Table Adaptor
Width adjustable universal neuro interface,
fitting OR tables with bars up to 70 mm.
Item no. 3011-00

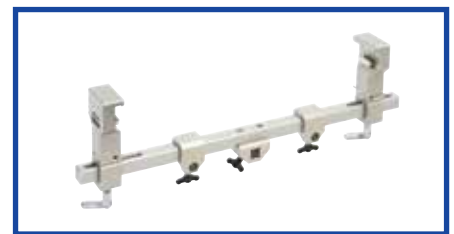

DORO® Side Rail OR Table Adaptor AMSCO®
Width adjustable universal neuro interface,
fitting OR tables with bars up to 125 mm.
Item no. 3011-10



AMSCO® Headrest Adaptor
Fits 3080 & 3085 series.
Item no. 3011-11

DORO® QR3 Headrest System Teflon®



DORO® Skull Clamp Teflon®
Item no. 3003-009



DORO® Swivel Adaptor Teflon®
Item no. 3002-009



DORO® Adjustable Base Unit Teflon®
Item no. 3001-009

DORO® QR3 Headrest System Teflon®
(shown with DORO® Skull Pins)
Item no. 3003-100

Description	Item no.
DORO® Skull Clamp Teflon®	3003-009
DORO® Swivel Adaptor Teflon®	3002-009
DORO® Adjustable Base Unit Teflon®	3001-009

^Δ Sitting positions: Only in conjunction with the DORO® Crossbar Adaptor (shown on page 13).
^Δ Lateral position: In conjunction with the DORO® Parkbench Base Unit (shown on page 7).
Skull Pins are not included in the DORO® QR3 Headrest System or DORO® QR3 Skull Clamp.

Key Features

- QR3 Quick-Rail® technology for quick connection of the DORO LUNA® Retractor System, DORO COBRA® Quick-Clamps or other accessories.
- Autoclavable.
- Machine washable.
- Conforms to WHO Infection Control Guidelines for cleaning and sterilization.
- Navigation ready.
- 3-pin rigid cranial fixation.
- For supine, prone, lateral or sitting position.^Δ
- Excellent stability and flexibility.

DORO® QR3 Skull Clamp Teflon®



Navigation tracking device adaptors can easily be attached on both sides of the Quick-Rail® (see page 13).

Teflon® coating makes the skull clamp autoclavable.

Quick-Rail® technology with straight and upright portions, can be located even under multiple layers of sterile drape.

Autoclavable

The DORO® QR3 Headrest System Teflon® can be sterilized for high risk infection patients.

Mix & Match The QR3 Skull Clamp Teflon® can be mounted to a radiolucent base unit and swivel adaptor by means of the Mix & Match Adaptor #3033-51 (see page 21).

DORO® Multi-Purpose Skull Clamp

The DORO® Multi-Purpose Skull Clamp is the most versatile DORO® Skull Clamp. Featuring all beneficial features of the DORO® QR3 Skull Clamp, this alteration can be set up for non-invasive or invasive procedures in adult as well as in pediatric cases.

Non-invasive set up possibilities.

Supports pediatric procedures by means of the optional 90 N/20 lbs Extension Bar. Item no. 3020-52

Stainless steel starbursts on both sides of the Quick-Rail® allows direct attachment of movement-sensitive Navigation Tracking Device Adaptors (see page 13).

DORO® Multi-Purpose Skull Clamp Item no. 3020-50

DORO® Head Support w/o (Gel Pads) Item no. 3020-03

DORO® Gel Ear Ring, with Base 90mm Item no. 3020-68

DORO® Gel Head Ring, with Base 90mm Item no. 3020-61

DORO® Trio Gel Pad, adjustable Item no. 3020-71

DORO® Gel Pad Item no. 3020-02

DORO® Gel Ear Ring, with Base 140mm Item no. 3020-70

DORO® Gel Head Ring, with Base 140mm Item no. 3020-63

DORO[®] QR3 MP Skull Clamp



DORO[®]
Single Pin Holder,
Item no. 3020-55



DORO[®]
Pin Holder,
Adjustable,
Pediatric
Item no. 3020-62



DORO[®]
PMT[®] Halo
System Holder
Item no. 1002.067

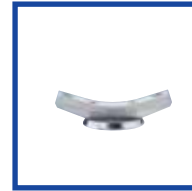

DORO[®]
Pin Holder,
Pediatric
Item no. 3020-01

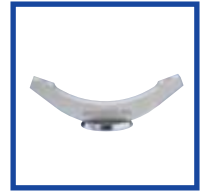

DORO[®]
Pin Holder,
Adult
Item no. 3020-56

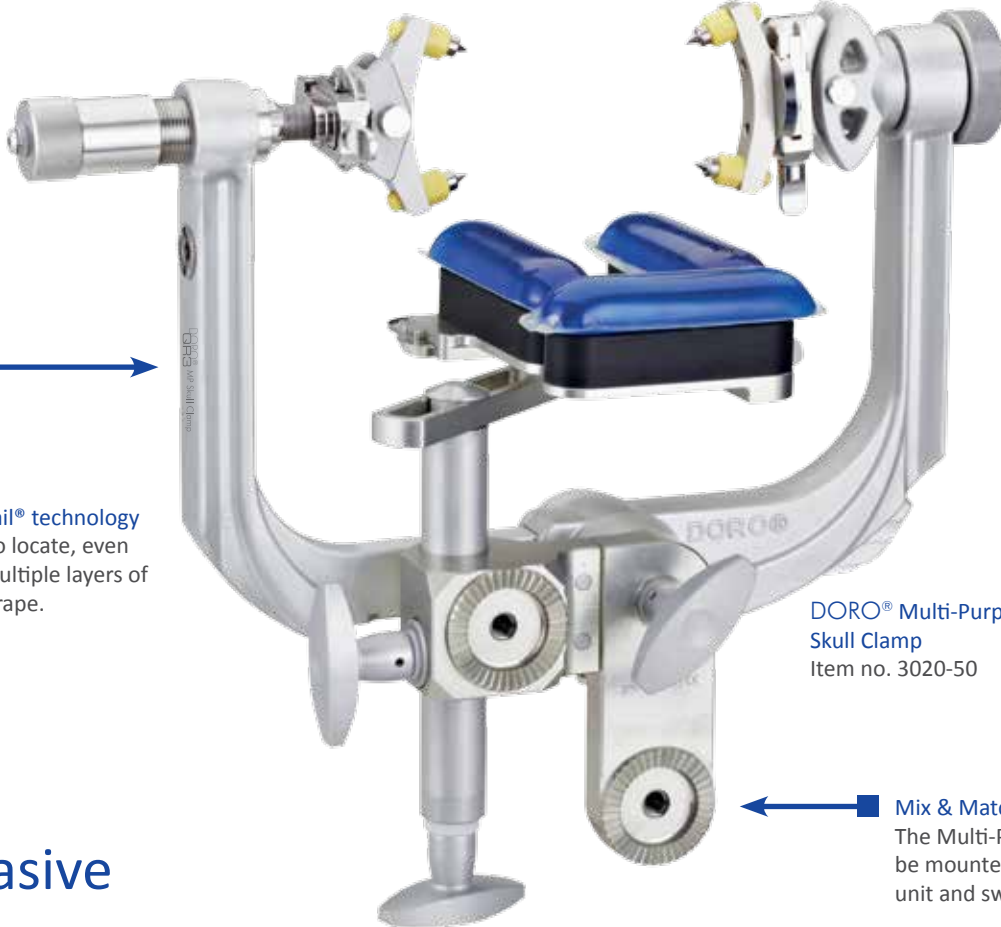

Quick-Rail[®] technology is easy to locate, even under multiple layers of sterile drape.

DORO[®] Multi-Purpose
Skull Clamp
Item no. 3020-50

Mix & Match
The Multi-Purpose Skull Clamp can be mounted to a radiolucent base unit and swivel adaptor (see page 21).

Invasive
set up possibilities.

DORO® Multi-Purpose Skull Clamp - available systems

DORO® Multi-Purpose Skull Clamp System

Item no. 3020-00

Description	Item no.
DORO® Disposable Skull Pins, Pediatric (36pcs)	3006-10
DORO® Pin Holder Pediatric	3020-01
DORO® Head Support (w/o Gel Pads)	3020-03
DORO® Multi-Purpose Skull Clamp	3020-50
DORO® Single Pin Holder	3020-55
DORO® Gel Head Ring w/ Base 90 mm (3pcs)	3020-61
DORO® Pin Holder Adjustable, Pediatric	3020-62
DORO® Gel Head Ring w/ Base 140 mm	3020-63
DORO® Adjustment Key	3020-65
DORO® Gel Ear Ring w/ Base 90 mm (2pcs)	3020-68
DORO® Trio Gel Pad (adjustable)	3020-71
DORO® Storage Case MPSC System	3020-001

DORO® Abbott Multi-Purpose Skull Clamp System Pediatric, Item no. 3021-00

Description	Item no.
DORO® Disposable Skull Pins, Pediatric (36pcs)	3006-10
DORO® Pin Holder Pediatric	3020-01
DORO® Head Support (w/o Gel Pads)	3020-03
DORO® Multi-Purpose Skull Clamp	3020-50
DORO® Extension Bar 90N/20lbs	3020-52
DORO® Single Pin Holder	3020-55
DORO® Gel Head Ring w/ Base 90 mm (3pcs)	3020-61
DORO® Pin Holder Adjustable, Pediatric	3020-62
DORO® Gel Head Ring w/ Base 140 mm	3020-63
DORO® Adjustment Key	3020-65
DORO® Gel Ear Ring w/ Base 90 mm (2pcs)	3020-68
DORO® Trio Gel Pad (adjustable)	3020-71
DORO® Storage Case MPSC System	3020-001

DORO® Universal Multi-Purpose Skull Clamp System

Item no. 3022-00

Description	Item no.
DORO® Disposable Skull Pins, Adult (36pcs)	3006-00
DORO® Disposable Skull Pins, Pediatric (36pcs)	3006-10
DORO® Pin Holder Pediatric	3020-01
DORO® Gel Pad	3020-02
DORO® Head Support (w/o Gel Pads)	3020-03
DORO® Multi-Purpose Skull Clamp	3020-50
DORO® Extension Bar 90N/20lbs	3020-52
DORO® Single Pin Holder	3020-55
DORO® Pin Holder Adult	3020-56
DORO® Gel Head Ring w/ Base 90 mm (3pcs)	3020-61
DORO® Pin Holder Adjustable, Pediatric	3020-62
DORO® Gel Head Ring w/ Base 140 mm	3020-63
DORO® Adjustment Key	3020-65
DORO® Gel Ear Ring w/ Base 90 mm (2pcs)	3020-68
DORO® Trio Gel Pad (adjustable)	3020-71
DORO® Storage Case MPSC System	3020-001



Storage Case MPSC System
Item no. 3020-001
(shown with Multi-Purpose Skull Clamp and Accessories).



DORO® Easy Connect Navigation Adaptors

- Connect directly to the integrated navigation starburst on the Quick-Rail® of the DORO® QR3 Skull Clamp, DORO® Multi-Purpose Skull Clamp and DORO® Skull Clamp Teflon®.
- Provide a very stable and secure connection of the navigation interface.
- Allow to position the navigation interface close to the surgical target.
- Custom interfaces available for:



DORO® Easy Connect Navigation Adaptor Stryker®
Item no. 1204.001
(Shown with Stryker navigation reference array).



DORO® Easy Connect Navigation Adaptor Brainlab
Item no. 1204.002
(Shown with Brainlab navigation reference array).

DORO® Easy Connect Navigation Adaptor Medtronic
Item no. 1204.003
(Shown with Medtronic navigation reference array).



DORO® Accessories



DORO® Headrest Wall Storage Unit
Item no. 3013-00
32" w x 37" h.
81 cm x 94 cm



DORO® Cervical Spine Support
Item no. 3012-00
Neck support for anterior spine surgery.



DORO® Crossbar Adaptor
Item no. 3007-00
For sitting positions.

- Needs 2x Universal Side Rail Fittings (item no. 3007-50, see page 7).



DORO® Reusable Skull Pins



DORO® Reusable Skull Pins
Stainless Steel
Adult
 Color: Black
 Item no. 3005-00
 (3 pins)



DORO® Reusable Skull Pins
Stainless Steel
Pediatric
 Color: Black
 Item no. 3004-00
 (3 pins)



DORO® Reusable Skull Pins
Titanium
Adult
 Color: Blue
 Item no. 3005-50
 (3 pins)



DORO® Reusable Skull Pins
Titanium
Pediatric
 Color: Blue
 Item no. 3004-50
 (3 pins)

DORO® Disposable Skull Pins



DORO® Disposable Skull Pins
Stainless Steel
Adult,
 Color: Blue
 Item no. 3006-00
 (36 pins), sterile



DORO® Disposable Skull Pins
Stainless Steel
Pediatric
 Color: Yellow
 Item no. 3006-10
 (36 pins), sterile



DORO® Disposable Skull Pins
Titanium
Adult
 Color: Turquoise
 Item no. 3006-20
 (36 pins), sterile



DORO® Disposable Skull Pins
Titanium
Pediatric
 Color: Green
 Item no. 3006-30
 (36 pins), sterile



DORO® Disposable Skull Pins
Stainless Steel
Adult
 Color: Black
 Item no. 3006-50
 (36 pins), sterile

DORO LUCENT® Disposable Skull Pins

- For intra-operative imaging applications using CT, MRI, X-Ray and Fluoroscopy.
- Designed to reduce imaging artifacts to an absolute minimum.
- The composition of titanium tip and high-performance reinforced polymer guarantees a precise, secure and rigid fixation.
- Sterile packaging.



The perfect balance of imaging quality and overall pin stability.

DORO LUCENT® Disposable Skull Pins
Adult, sterile
 Color: Black
 Item no. 1106.003 (3 pins)

DORO LUCENT® Disposable Skull Pins
Adult, sterile
 Color: Black
 Item no. 1106.103 (9 pins)

DORO® Aluminum Swivel Horseshoe Headrest



Optional Extension Bar
for skeletal traction.

Gel Pads are interchangeable
for adult or pediatric
applications.

Mix & Match
with DORO LUCENT® Headrest System
by means of adaptor no. 3033-51
(see page 21).

Proper patient positioning
due to vertical and lateral
adjustment possibilities.

Adult versions

DORO® Swivel Horseshoe Headrest System, Adult with Extension Bar Item no. 3009-00

Description	Item no.
DORO® Horseshoe Base	3009-01
DORO® Horseshoe Pad, Adult, right	3009-10
DORO® Horseshoe Pad, Adult, left	3009-11
DORO® Extension Bar Horseshoe	3009-25

DORO® Swivel Horseshoe Headrest System, Adult without Extension Bar Item no. 3009-02

Description	Item no.
DORO® Horseshoe Base	3009-01
DORO® Horseshoe Pad, Adult, right	3009-10
DORO® Horseshoe Pad, Adult, left	3009-11

Pediatric versions

DORO® Swivel Horseshoe Headrest System, Pediatric with Extension Bar Item no. 3008-00

Description	Item no.
DORO® Horseshoe Base	3009-01
DORO® Horseshoe Pad, Pediatric, right	3008-10
DORO® Horseshoe Pad, Pediatric, left	3008-11
DORO® Extension Bar Horseshoe	3009-25

DORO® Swivel Horseshoe Headrest System, Pediatric without Extension Bar Item no. 3008-02

Description	Item no.
DORO® Horseshoe Base	3009-01
DORO® Horseshoe Pad, Pediatric, right	3008-10
DORO® Horseshoe Pad, Pediatric, left	3008-11

DORO LUCENT® Headrest System

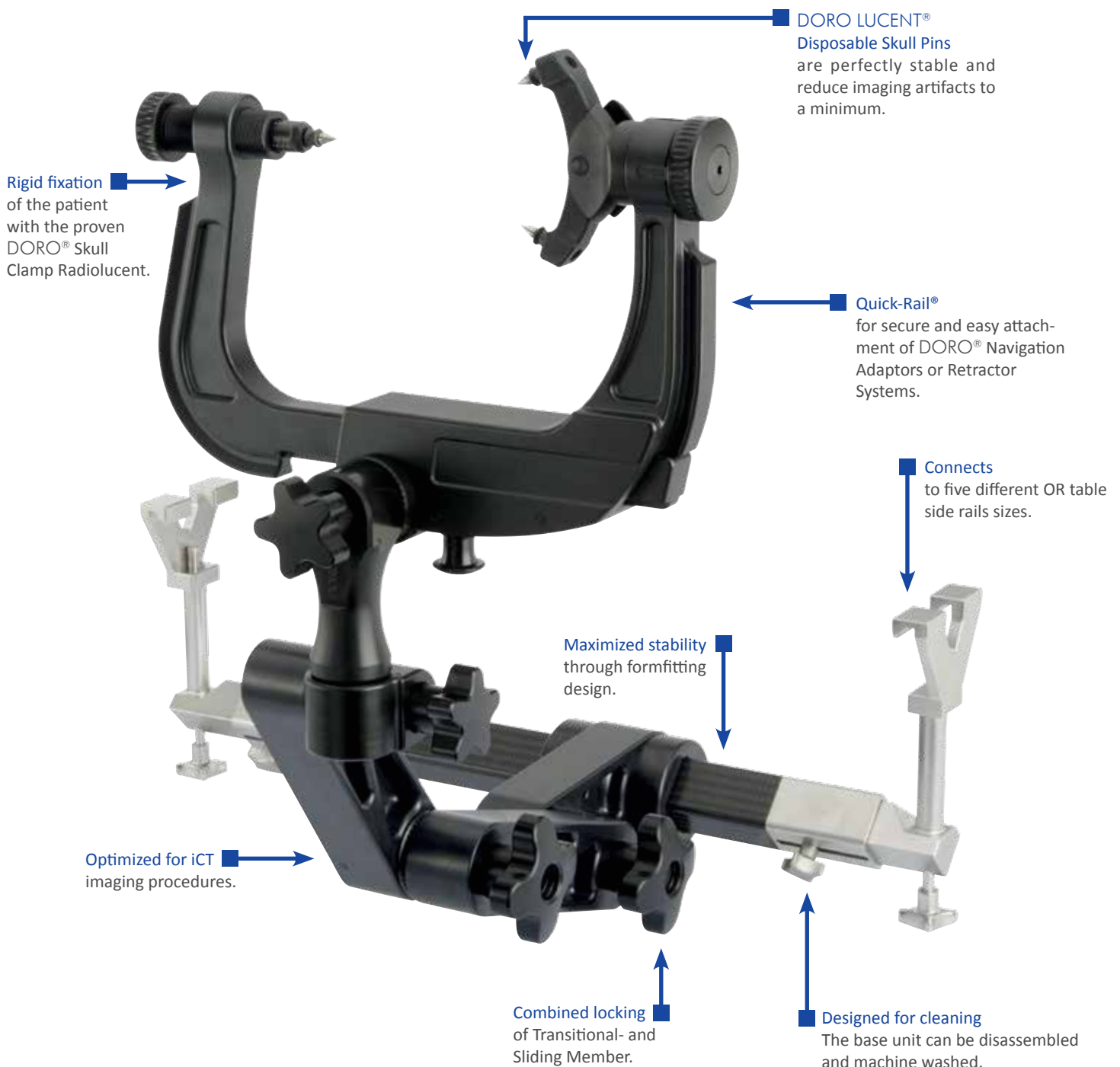

DORO LUCENT® Headrest System

DORO LUCENT® Headrest System

Item no. 1101.020

Description	Item no.
DORO LUCENT® Disposable Skull Pins, Adult	1106.003
DORO LUCENT® Storage Case Headrest System	1101.030
DORO LUCENT® Base Unit	1101.021
DORO LUCENT® Locking Transitional Member	1101.031
DORO LUCENT® Transitional Member	1101.026
DORO® Swivel Adaptor Radiolucent	3033-00
DORO® Skull Clamp Radiolucent	3034-00

The DORO LUCENT® Headrest System is the cranial stabilization system of choice for all procedures applying X-Ray & iCT imaging. The system is highly adaptable to the distinct needs of the surgeon and his next procedure at hand.

The system features the proven, completely metal free DORO® Skull Clamp Radiolucent with its beneficial Quick-Rail® interfaces for easy attachment of navigation tracking devices, retractor systems and other accessories.

The DORO LUCENT® Base Unit features a completely new and streamlined design. With a clear focus on usability, cleanability and radiolucency, this base unit provides a solid foundation for all X-Ray & iCT-imaging supported procedures.



Set up with
DORO LUCENT® Horseshoe Headrest ENT
(see page 23).



Set up with
DORO® Horseshoe RS Headrest Radiolucent
(see page 22).



Mix & Match set up with
DORO® QR3 Skull Clamp Aluminum
(see page 21).

DORO® Skull Clamp Radiolucent

The completely metal free DORO® Skull Clamp Radiolucent provides 3-pin rigid cranial fixation. The Quick-Rail® on both sides allows an easy and secure connection of accessories, even over multiple layers of sterile drape.

DORO® Skull Clamp Radiolucent

Item no. 3034-00

 (shown with DORO LUCENT® Disposable Skull Pins, see page 14).



DORO LUCENT® Headrest System Accessories



DORO® Swivel Adaptor Radiolucent
Item no. 3033-00



DORO® Swivel Adaptor Radiolucent, short
Item no. 3033-10



DORO® Universal DRF Adaptor Radiolucent (includes key)
Item no. 3038-30



DORO LUCENT® Storage Case Headrest System
Item no. 1101.030



DORO LUCENT® Locking Transitional Member
Item no. 1101.031



DORO LUCENT® Transitional Member
Item no. 1101.026

DORO® Radiolucent OR Table Adaptors & Transitional Members



DORO® Angiography Table Adaptor SIEMENS, Radiolucent
for Artis Table
Item no. 4003-00



DORO® Table Adaptor medifa®, Radiolucent
for medifa® Hesse OR Table MRT 5600 II
Item no. 4004.001



DORO® Table Adaptor STERIS, Radiolucent
for STERIS Carbon OR Tables CMAX XRAY
Item no. 4004.002



DORO® Table Adaptor MAQUET, Radiolucent
for Alphamaquet 1150 and Magnus 1180*
Item no. 3031-50

* Only in conjunction with MAQUET adaptor (MAQUET item no. 6005.25A0).



DORO® Transitional Member Radiolucent, long (160 mm)
Item no. 3032-10



DORO® Transitional Member Radiolucent, short (120 mm)
Item no. 3032-20

■ Compatible to DORO® Table Adaptors Radiolucent, item nos 3031-50, 4003-00, 4004.001, 4004.002.

■ Compatible to DORO® Table Adaptors Radiolucent, item nos 3031-50, 4003-00, 4004.001, 4004.002.

Mix & Match

DORO® radiolucent and metal items.



DORO® Mix & Match for Cranial and Spine Applications

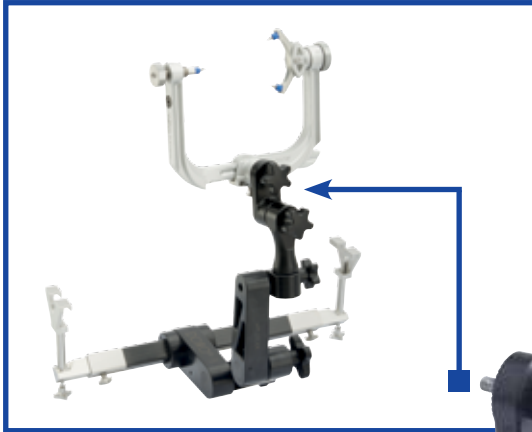

CONFIGURATION A Cervical Spine Applications

Description	Item no.
DORO® QR3 Skull Clamp	1001.001
DORO LUCENT® Base Unit	1101.021
DORO LUCENT® Locking Transitional Member	1101.031
DORO LUCENT® Transitional Member	1101.026
DORO® Swivel Adaptor Radiolucent	3033-00
DORO® Interface Skull Clamp Aluminum (to RDL Swivel Adaptor)	3033-51

DORO® Interface Skull Clamp Aluminum (to RDL Swivel Adaptor)
Item no. 3033-51

- Allows the connection of an aluminum skull clamp to a radiolucent swivel adaptor and base unit.



CONFIGURATION B Cranial and Cervical Spine Applications with CT, DSA, Fluoroscopy

Description	Item no.
DORO® Base Unit Aluminum	3001-00
DORO® Transitional Member Radiolucent (to ALU Base Unit)	3032-00
DORO® Swivel Adaptor Radiolucent	3033-00
DORO® Skull Clamp Radiolucent	3034-00

DORO® Transitional Member Radiolucent (to ALU Base Unit)
Item no. 3032-00

- Allows the connection of a radiolucent swivel adaptor and skull clamp to an aluminum base unit.



CONFIGURATION C Cranial Applications with C-Arms, DSA, Fluoroscopy

Description	Item no.
DORO® Base Unit Aluminum	3001-00
DORO® Swivel Adaptor Aluminum	3002-00
DORO® Interface Skull Clamp Radiolucent (to ALU Swivel Adaptor)	3033-50
DORO® Skull Clamp Radiolucent	3034-00

DORO® Interface Skull Clamp Radiolucent (to ALU Swivel Adaptor)
Item no. 3033-50

- Allows the connection of a radiolucent skull clamp to an aluminum swivel adaptor and base unit.

DORO® Radiolucent Swivel Horseshoe Headrest

Adult version

DORO® Swivel Horseshoe Headrest Radiolucent System, Adult, with Extension Bar
Item no. 3036-00

Description	Item no.
DORO® Horseshoe Base Radiolucent with Extension Bar	3036-50
DORO® Horseshoe Pad, Adult, right	3009-10
DORO® Horseshoe Pad, Adult, left	3009-11

Pediatric version

DORO® Swivel Horseshoe Headrest Radiolucent System, Pediatric, with Extension Bar
Item no. 3035-00

Description	Item no.
DORO® Horseshoe Base Radiolucent with Extension Bar	3036-50
DORO® Horseshoe Pad, Pediatric, right	3008-10
DORO® Horseshoe Pad, Pediatric, left	3008-11

Extension Bar
for skeletal traction.



Gel Pads are interchangeable for adult or pediatric applications.

Quick-Rail® technology for attaching DORO COBRA® Retractor Arms by means of the DORO COBRA® Quick-Clamp for Radiolucent Quick-Rail® (see page 30).

Mix & Match with DORO® Headrest System Aluminum by means of adaptor no. 3033-50 (see page 21).

DORO® Radiolucent Horseshoe RS Headrest

Adult version

DORO® Horseshoe RS Headrest Radiolucent, Adult, with Extension Bar
Item no. 3036-70

Description	Item no.
DORO® Horseshoe RS Base Radiolucent with Extension Bar	3036-71
DORO® Horseshoe Pad, Adult, right	3009-10
DORO® Horseshoe Pad, Adult, left	3009-11

Pediatric version

DORO® Horseshoe RS Headrest Radiolucent, Pediatric, with Extension Bar
Item no. 3035-70

Description	Item no.
DORO® Horseshoe RS Base Radiolucent with Extension Bar	3036-71
DORO® Horseshoe Pad, Pediatric, right	3008-10
DORO® Horseshoe Pad, Pediatric, left	3008-11



More compact system set up by connecting the Horseshoe RS directly to the DORO LUCENT® Transitional Member.

DORO LUCENT® Horseshoe Headrest ENT

The DORO LUCENT® Horseshoe Headrest ENT is designed to match the distinct needs of patient positioning for ENT procedures. It is directly mounted to the DORO LUCENT® Transitional Member with the open part of the horseshoe facing away from the OR table.

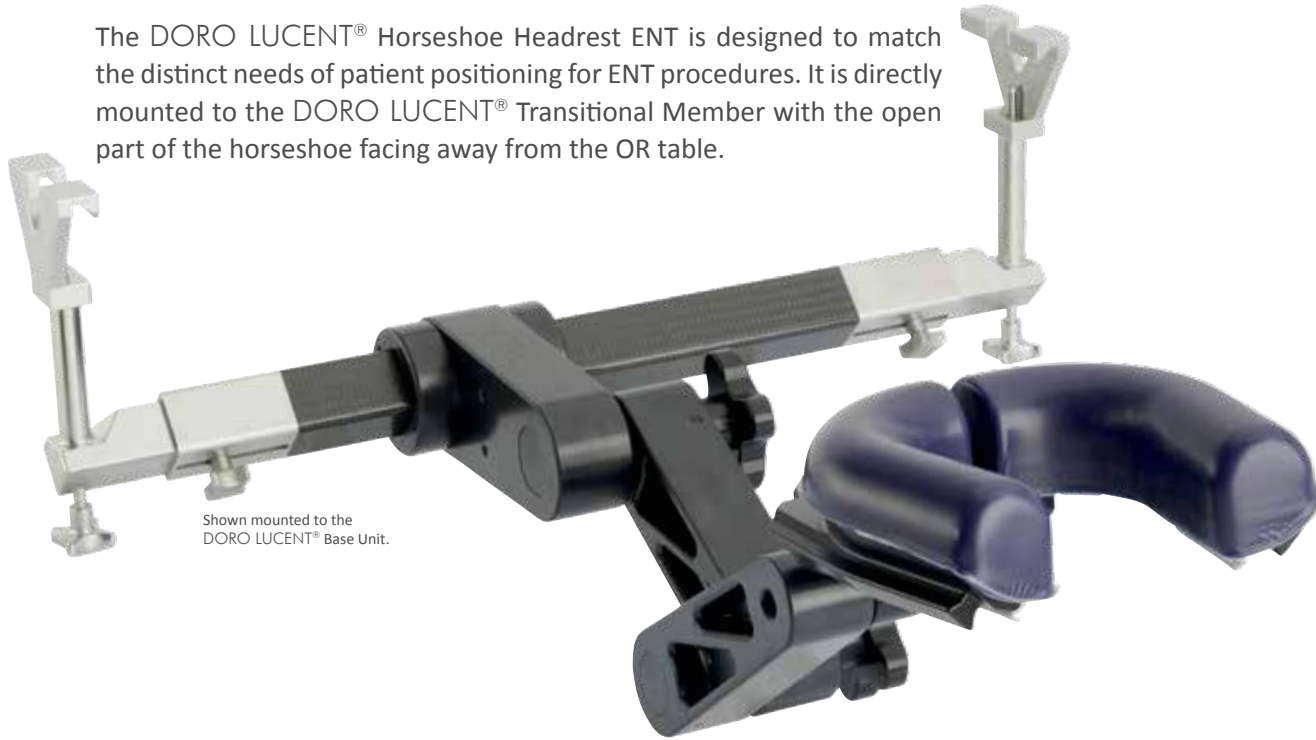

Shown mounted to the DORO LUCENT® Base Unit.

Adult version

DORO LUCENT® Horseshoe Headrest ENT, Adult Item no. 1101.007	
Description	Item no.
DORO LUCENT® Horseshoe Headrest ENT, RDL w/o Gel Pads	1101.006
DORO® Horseshoe Pad, Adult, right	3009-10
DORO® Horseshoe Pad, Adult, left	3009-11

Pediatric version

DORO LUCENT® Horseshoe Headrest ENT, Pediatric Item no. 1101.008	
Description	Item no.
DORO LUCENT® Horseshoe Headrest ENT, RDL w/o Gel Pads	1101.006
DORO® Horseshoe Pad, Pediatric, right	3008-10
DORO® Horseshoe Pad, Pediatric, left	3008-11

DORO® Navigation Adaptors Radiolucent



DORO® Navigation Adaptor Quick-Rail® Radiolucent, Stryker®
Item no. 3033-64

- Connects directly to the Quick-Rail® of the DORO® Radiolucent Skull Clamp.
- For Stryker® Navigation Device.
- Comes with Torx Screwdriver T45 Item no. 3033-67.



DORO® Navigation Adaptor Quick-Rail® Radiolucent, Medtronic
Item no. 3033-65

- Connects directly to the Quick-Rail® of the DORO® Radiolucent Skull Clamp.
- For Medtronic Navigation Device.
- Comes with Torx Screwdriver T45 Item no. 3033-67.



DORO® Navigation Adaptor Quick-Rail® Radiolucent, Brainlab
Item no. 3033-66

- Connects directly to the Quick-Rail® of the DORO® Radiolucent Skull Clamp.
- For Brainlab Navigation Device.
- Comes with Torx Screwdriver T45 Item no. 3033-67.

DORO LUCENT® iMRI Headrest Systems

DORO LUCENT® iMRI Headrest Systems are used in head and neck surgery when rigid cranial stabilization is desired and when intraoperative Magnetic Resonance Imaging (iMRI) is used. A variant of the proven DORO® Radio-lucent Skull Clamp is mounted to the OR transfer board interface using a special adaptor, allowing the surgeon to use all its beneficial features and the known workflow from a standard rigid 3-pin fixation. These special headrest systems are custom made for selected OR table / MRI Scanner combinations and allow stabilizing the patient's head in a safe and secure position for surgery including the patient transfer to MR imaging.

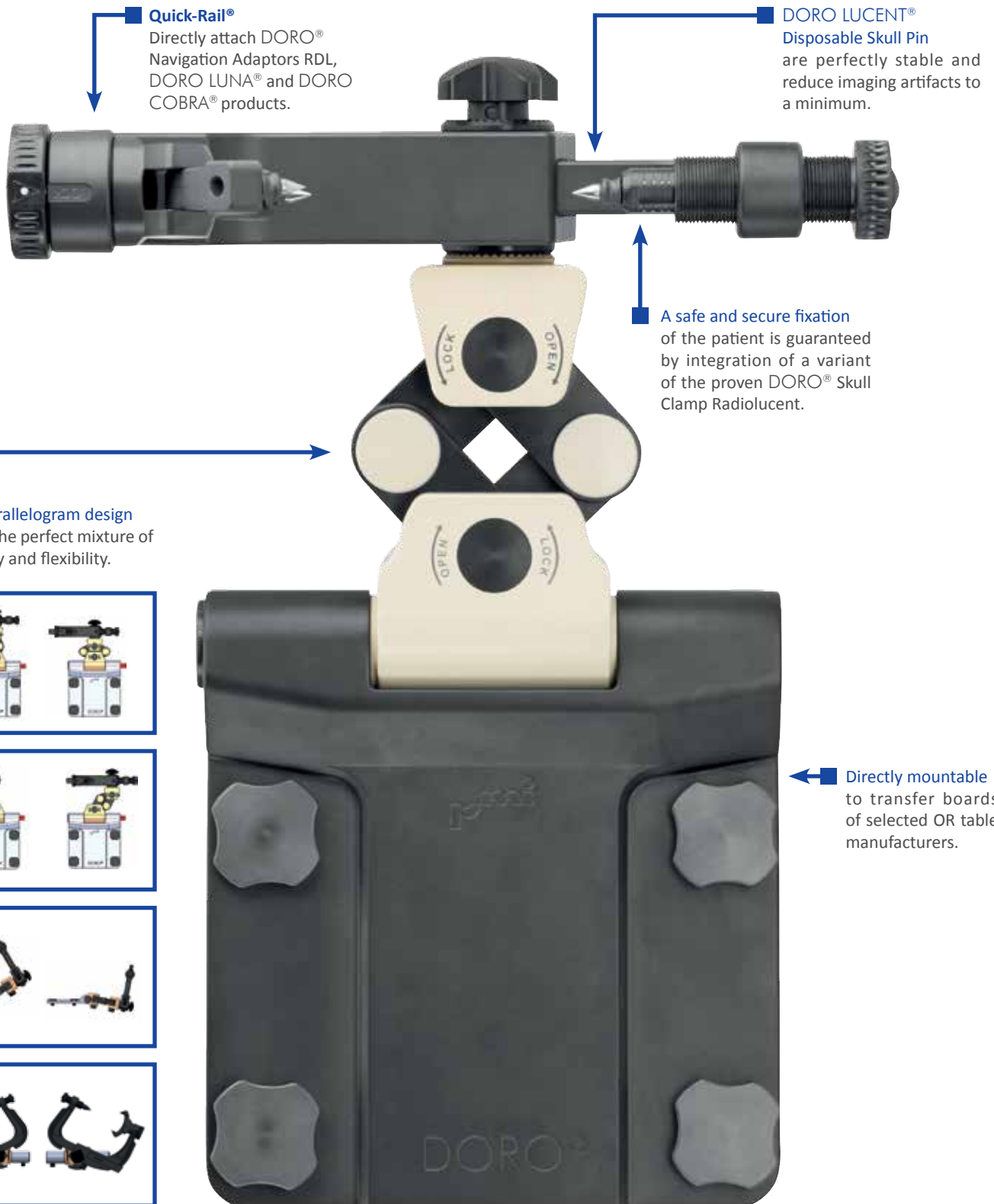

DORO LUCENT® iMRI Headrest Systems

Available for MAQUET OR tables

DORO LUCENT® Headrest System MAQUET for SIEMENS Aera/Skyra MRI systems Item no. 4003.100

Description	Item no.
DORO® Skull Clamp Radiolucent for DORO LUCENT® Parallelogram Adaptor	4003.001
DORO® Adjusting Wrench for DORO LUCENT® Parallelogram Adaptor	4003.011
DORO LUCENT® Parallelogram Adaptor MAQUET for SIEMENS Aera/Skyra MRI Systems	4003.111
DORO LUCENT® Disposable Skull Pins, Adult (3 pcs)	1106.003

DORO LUCENT® Headrest System MAQUET for PHILIPS Ingenia Item no. 4003.300

Description	Item no.
DORO® Skull Clamp Radiolucent for DORO LUCENT® Parallelogram Adaptor	4003.001
DORO® Adjusting Wrench for DORO LUCENT® Parallelogram Adaptor	4003.011
DORO LUCENT® iMRI Parallelogram Adaptor MAQUET	4003.311
DORO LUCENT® Disposable Skull Pins, Adult (3 pcs)	1106.003

DORO LUCENT® iMRI Headrest System MAQUET for GE Item no. 4003.400

Description	Item no.
DORO® Skull Clamp Radiolucent for DORO LUCENT® Parallelogram Adaptor	4003.001
DORO® Adjusting Wrench for DORO LUCENT® Parallelogram Adaptor	4003.011
DORO LUCENT® iMRI Parallelogram Adaptor MAQUET	4003.311
DORO LUCENT® iMRI Transfer Collision Indicator MAQUET for GE	4003.4XX
DORO LUCENT® Disposable Skull Pins, Adult (3 pcs)	1106.003

Available for TRUMPF OR tables

DORO LUCENT® Headrest System TRUMPF for SIEMENS Aera/Skyra MRI systems Item no. 4003.200

Description	Item no.
DORO® Skull Clamp Radiolucent for DORO LUCENT® Parallelogram Adaptor	4003.001
DORO® Adjusting Wrench for DORO LUCENT® Parallelogram Adaptor	4003.011
DORO LUCENT® Parallelogram Adaptor TRUMPF for SIEMENS Aera/Skyra MRI Systems	4003.211
DORO LUCENT® iMRI Pad TRUMPF	4003.212
DORO LUCENT® Disposable Skull Pins, Adult (3 pcs)	1106.003

Using a collision indicator with a DORO LUCENT® iMRI Headrest System is mandatory to verify an unobstructed patient transfer. Please contact your local DORO® representative for details.

With the first installation of a DORO LUCENT® iMRI Headrest System, an expert training is mandatory (see page 26). Please contact your local DORO® representative for details.



DORO LUCENT® iMRI Headrest Systems Trainings

To assist our customers in maximizing the full potential of the DORO LUCENT® iMRI Headrest Systems, we are offering dedicated trainings for these devices. These trainings will be held on site by DORO LUCENT® application specialists and will cover essential and advanced product knowledge. The training will especially focus on:

- System set up.
- Setting options and movement capabilities.
- Patient positioning.
- OR workflow (handling of the system, coils and sterile barrier).
- Patient transfer to intra-operative imaging.
- Alternative usage possibilities (CT, X-Ray and others).

Product Training
Item no. 8001



DORO® Skull Clamp Radiolucent for Spinal Frames

This modification of our proven, metal free DORO® Skull Clamp Radiolucent is designed for spinal surgeries and can be mounted to all established spinal OR tables and spinal frames.

The new, slim design allows the skull clamp to be lowered between the rails of the open frame, simplifying patient positioning and imaging procedures.



DORO® Skull Clamp Radiolucent for Spinal Frames

Item no. 4004.101



The DORO® Skull Clamp Radiolucent for Spinal Frames is shown with DORO LUCENT® Skull Pins which are not included. (The DORO LUCENT® Skull Pin is shown on page 14).

More flexibility in patient positioning.



Standard DORO® Skull Clamp Radiolucent shown mounted to a MIZUHO OSI Insite® table.



DORO® Skull Clamp Radiolucent for Spinal Frames shown mounted to a MIZUHO OSI Insite® table.

DORO LUNA®

Retractor System

Our top-of-the-line retractor system. Six degrees of freedom offer unparalleled flexibility and an unobstructed access to the surgical field at any time of the procedure. The variability of the DORO LUNA® Retractor System can be further enhanced with additional adaptors.

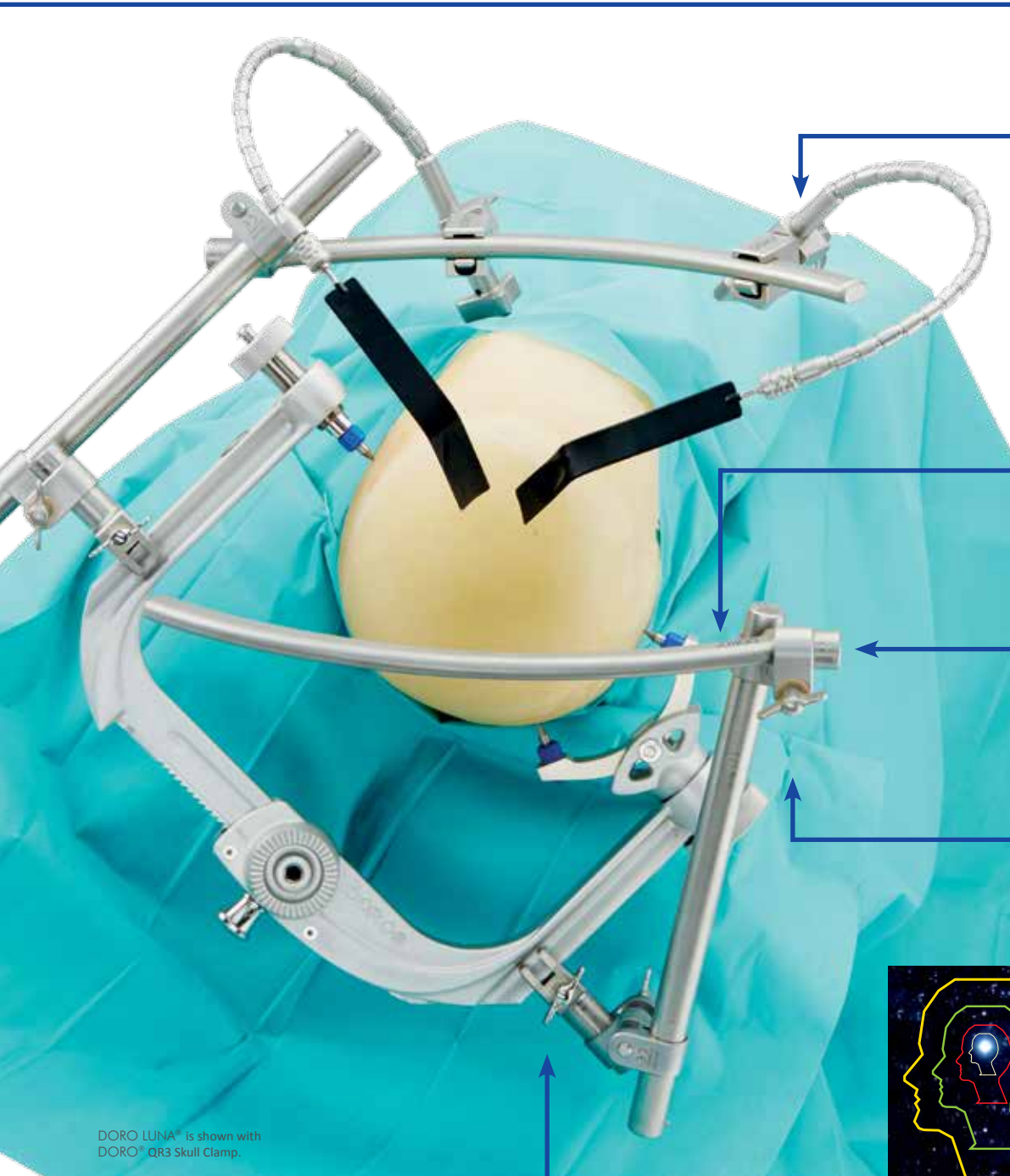

■ Snap-on attachment of DORO COBRA® Flexible Rotary Arms on any desired position on the curve.

■ Comfortable hand support due to ergonomic curve design.

■ Remarkable flexibility DORO LUNA® Curve can be positioned parallel to the floor, independent of skull clamp position.

■ No tool/key needed to adjust clamping mechanisms.

DORO LUNA® is shown with DORO® QR3 Skull Clamp.

■ Quick and easy set up
DORO LUNA® attaches directly to the Quick-Rail®, even over multiple layers of sterile drape.

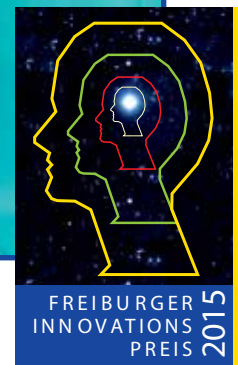

Winner of the 2015 Freiburger Innovation Award

DORO LUNA® Retractor System



DORO LUNA® Standard System

Item no. 1203.100

(Shown mounted to the DORO® QR3 Skull Clamp).

DORO LUNA® Retractor System – Standard System

Item no. 1203.100

Description	Item no.
DORO COBRA® Flexible Rotary Arm 280mm (2 pcs)	1201.006
DORO® Retractor Sterilization Tray	1201.091
DORO LUNA® Quick-Clamp for Quick-Rail® (2 pcs)	1203.001
DORO LUNA® Coupling (4 pcs)	1203.002
DORO LUNA® Rod (2 pcs)	1203.003
DORO LUNA® Curve (2 pcs)	1203.004
DORO LUNA® Sterilization Tray	1203.091
DORO® Blade Set 102 mm, Black Coated, 5 pcs (2 sets)	3116-101

DORO LUNA® Standard Retractor System & DORO® QR3 Skull Clamp

1203.110

DORO LUNA® Standard Retractor System & DORO® QR3 Headrest System

1203.120



DORO LUNA® Compact System

Item no. 1203.200

(Shown mounted to the DORO® QR3 Skull Clamp).

DORO LUNA® Retractor System – Compact System

Item no. 1203.200

Description	Item no.
DORO COBRA® Flexible Rotary Arm 280mm (2 pcs)	1201.006
DORO® Retractor Sterilization Tray	1201.091
DORO LUNA® Quick-Clamp for Quick-Rail®	1203.001
DORO LUNA® Coupling (2 pcs)	1203.002
DORO LUNA® Rod	1203.003
DORO LUNA® Curve	1203.004
DORO LUNA® Sterilization Tray	1203.091
DORO® Blade Set 102 mm, Black Coated, 5 pcs (2 sets)	3116-101

DORO LUNA® Compact Retractor System & DORO® QR3 Skull Clamp

1203.210

DORO LUNA® Compact Retractor System & DORO® QR3 Headrest System

1203.220



Directly attach the DORO LUNA® Retractor System to the DORO® Skull Clamp Radiolucent by means of the DORO LUNA® Quick-Clamp for Radiolucent Quick-Rail®.



DORO LUNA® Quick-Clamp
for Radiolucent Quick-Rail®
Item no. 1203.009

DORO COBRA® Quick-Clamps



These adaptors allow the direct attachment of DORO COBRA® Flexible Rotary Arms to the Quick-Rail® of the DORO® QR3 Aluminum or Radiolucent Skull Clamp. This minimizes the obstruction of the surgical field compared to conventional retractor systems.



DORO COBRA® Quick-Clamp for Aluminum Quick-Rail®
Item no. 1201.021



DORO COBRA® Quick-Clamp for Radiolucent Quick-Rail®
Item no. 1201.022



Mix & Match DORO COBRA® Flexible Rotary Arms with the Radiolucent Quick-Rail®.



Directly connect DORO COBRA® Flexible Rotary Arms to the Quick-Rail®.

Mix & Match

DORO LUNA® and DORO COBRA® devices can directly be connected to the aluminum or radiolucent Quick-Rail®, maximizing flexibility and set up possibilities alike.

DORO LUNA®



DORO LUNA® Quick-Clamp
for Radiolucent Quick-Rail®
Item no. 1203.009

DORO COBRA®



DORO COBRA® Quick-Clamp
for Radiolucent Quick-Rail®
Item no. 1201.022



DORO COBRA® Flexible Rotary Arms



DORO COBRA²®

- Smooth and very precise movement.
- Stable after repositioning under tension.
- „Clicks“ on DORO LUNA® Curve. Easy to use and move to the desired location.
- Provides 360° body rotation while mounted for extra flexibility in positioning.
- Thumb lock - no tool necessary.
- Minimized obstruction in the surgical field.

DORO COBRA® Flexible Rotary Arms	
Description	Item no.
DORO COBRA® Flexible Rotary Arm 200 mm	1201.005
DORO COBRA® Flexible Rotary Arm 280 mm	1201.006
DORO COBRA® Flexible Rotary Arm 350 mm	1201.007
DORO COBRA® Flexible Rotary Arm 420 mm	1201.008

DORO® Flexible Arms

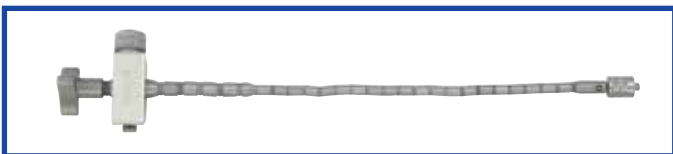

DORO® Flexible Arms	
Description	Item no.
DORO® Flexible Arm 230 mm	3114-34
DORO® Flexible Arm 300 mm	3114-35

DORO® Flexible Rotary Arms	
Description	Item no.
DORO® Flexible Rotary Arm 200 mm	3114-36
DORO® Flexible Rotary Arm 280 mm	3114-37
DORO® Flexible Rotary Arm 350 mm	3114-38

DORO® Quick-Clamp with Starburst for Radiolucent Quick-Rail®

The DORO® Quick-Clamp with Starburst for Radiolucent Quick-Rail® serves as an intuitive interface* for devices used in frameless stereotactic or endoscopic procedures.

Designed for use over the sterile barrier and formfittingly connected to the proven Quick-Rail® of the DORO® Skull Clamp Radiolucent, the adaptor provides a stable and secure connection point for third party devices.



**DORO® Quick-Clamp with Starburst
for Radiolucent Quick-Rail®**
Item no. 3033-69

*The interface is designed to bear a max. load of 16.8 Nm (which equals a weight of 3.4 kg attached to a horizontally mounted, 50 cm long arm). It is validated for use with the Brainlab VarioGuide™. It is the responsibility of the user to verify that third party devices can safely be secured to the DORO® Quick-Clamp with Starburst for Radiolucent Quick-Rail®. The product is shown mounted to a DORO® Skull Clamp Radiolucent.

DORO® Quick-Clamp Halo Brain Retractor System

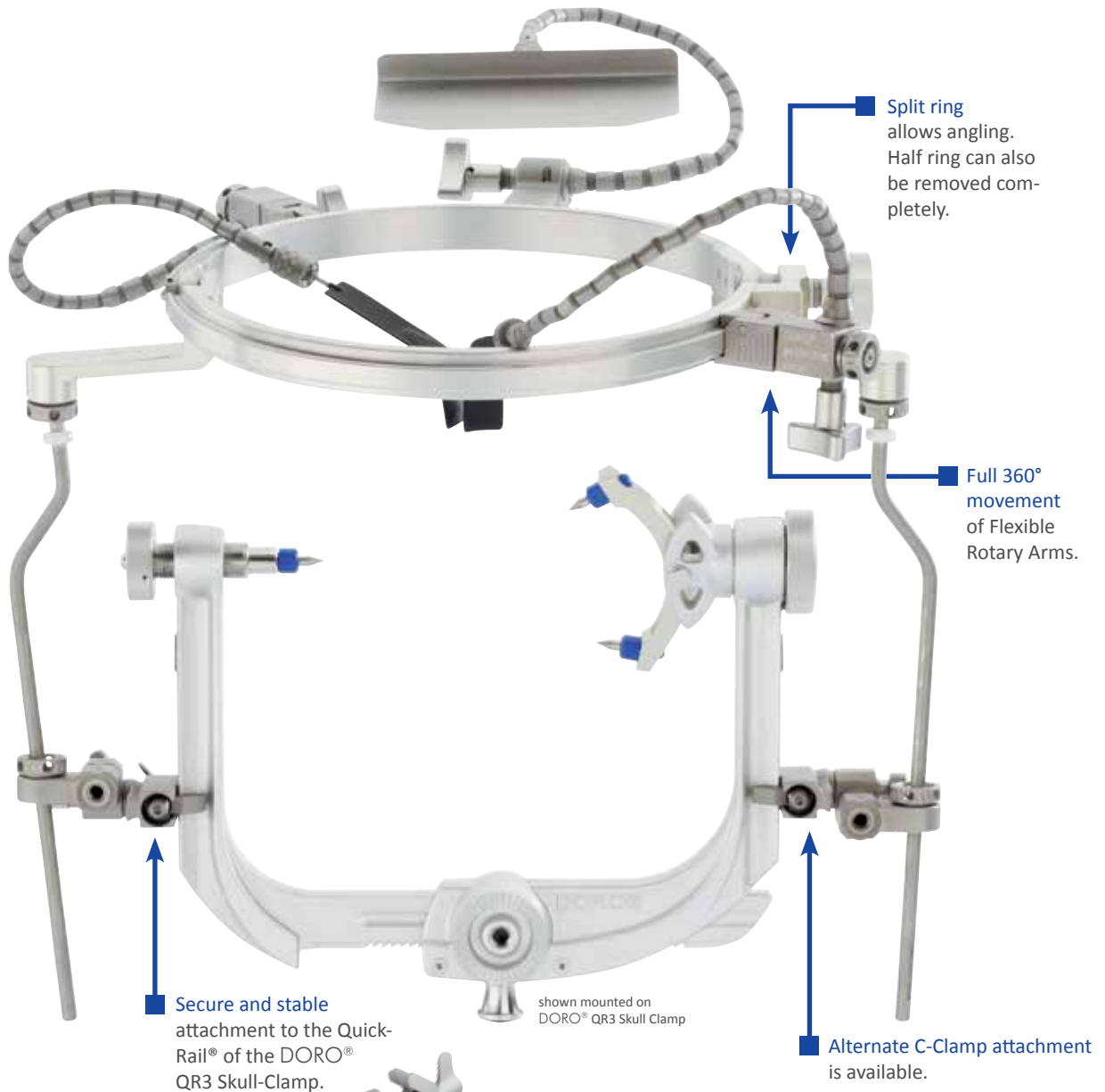

DORO® Quick-Clamp Halo Retractor System Item no. 1202.100T

Description	Item no.
DORO® Quick-Clamp Halo Coupling Set (2 pcs)	1202.010
DORO® Halo Ring	3110-01
DORO® Halo Support Rod 8 mm (2 pcs)	3110-08
DORO® Halo Universal Key (2 pcs)	3110-80
DORO® Halo Pattie Tray	3110-85
DORO® Flexible Rotary Arm 280 mm (3 pcs)	3114-37
DORO® Blade Set 102 mm, Black Coated, 5 pcs (2 sets)	3116-101
DORO® Micro Blade Set, 6 pcs	3116-20
DORO® Halo Sterilization Case w/ Rack	3117-00

DORO® Halo Retractor System w/ C-Clamp Item no. 3100-00

Description	Item no.
DORO® Halo Ring	3110-01
DORO® Halo Support Rod 8 mm (2 pcs)	3110-08
DORO® Halo Support Bracket w/ C-Clamp Adaptor (2 pcs)	3110-51
DORO® Halo Universal Key (2 pcs)	3110-80
DORO® Halo Pattie Tray	3110-85
DORO® Flexible Arm 230 mm (3 pcs)*	3114-34
DORO® Blade Set 102mm, Black Coated, 5 pcs (2 sets)	3116-101
DORO® Micro Blade Set, 6 pcs	3116-20
DORO® Halo Sterilization Case w/ Rack	3117-00

DORO® 'Rail-It' and Retractor Accessories

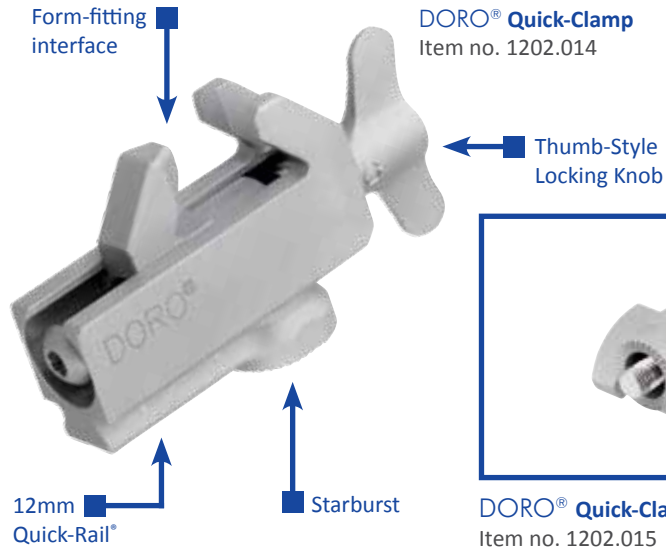

DORO® Quick-Clamp Coupling Universal
Item no. 1202.015



DORO® Halo Support Rod Holder
Item no. 1202.016



DORO® Quick-Clamp Halo Coupling Set
Item no. 1202.010

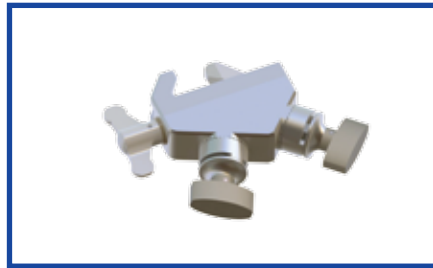

DORO® Quick-Clamp with Interface Mizuho-Type Retractors
Item no. 1201.045



DORO® Halo Support Bracket with C-Clamp Adaptor
Item no. 3110-51



DORO® Halo Ring
Item no. 3110-01

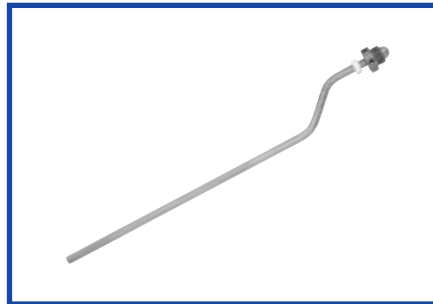

DORO® Halo Support Rod 8mm
Item no. 3110-08



DORO® Clamp Body for Skin Hooks
Item no. 3114-53



DORO® Halo Pattie Tray
Item no. 3110-85



DORO® Mini Vice
Item no. 3114-54



DORO® Halo Universal Key
Item no. 3110-80



**DORO® Blade Set 152 mm,
Black Coated, 5 pcs.**
Item no. 3116-10

Description	Item no.
152 x 6 mm	3116-11
152 x 10 mm	3116-12
152 x 16 mm	3116-13
152 x 19 mm	3116-14
152 x 25 mm	3116-15
152 x 13 mm (not in set)	3116-16



**DORO® Blade Set 152 mm,
Conical, Black Coated, 5 pcs.**
Item no. 3116-60

Description	Item no.
152 x 2 mm	3116-61
152 x 3 mm	3116-62
152 x 4 mm	3116-63
152 x 5 mm	3116-64
152 x 6 mm	3116-65



**DORO® Blade Set 102 mm,
Rounded Tip, Black Coated, 5 pcs.**
Item no. 3116-70

Description	Item no.
102 x 6 mm	3116-71
102 x 10 mm	3116-72
102 x 16 mm	3116-73
102 x 19 mm	3116-74
102 x 25 mm	3116-75

**DORO® Blade Set 102 mm,
Black Coated, 5 pcs.**
Item no. 3116-101

Description	Item no.
102 x 6 mm	3116-111
102 x 10 mm	3116-121
102 x 16 mm	3116-131
102 x 19 mm	3116-141
102 x 25 mm	3116-151
102 x 13 mm (not in set)	3116-161

**DORO® Blade Set 102 mm,
Conical, Black Coated, 5 pcs.**
Item no. 3116-601

Description	Item no.
102 x 2 mm	3116-611
102 x 3 mm	3116-621
102 x 4 mm	3116-631
102 x 5 mm	3116-641
102 x 6 mm	3116-651

Key Features

- Extensive accessories program with black mat finish retractor blades, in conical, rounded and square configurations.



DORO® Adaptor for Flat Brain Spatula

Item no. 1201.046

Fits all DORO® Retractor Arms.

DORO® Micro Blades



DORO® Micro Blade Set, 6 pcs.
Item no. 3116-20

Description	Item no.
114 x 2 mm	3116-21
114 x 4 mm	3116-22
140 x 2 mm	3116-23
140 x 4 mm	3116-24
165 x 2 mm	3116-25
165 x 4 mm	3116-26

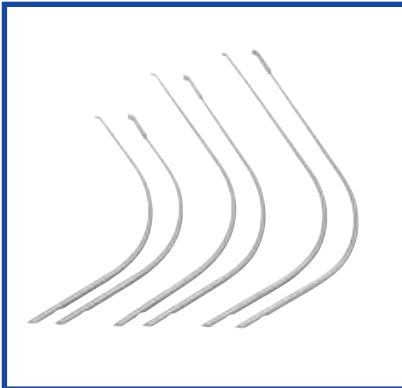

DORO® Micro Blade Set, Serrated, 6 pcs.
Item no. 3116-30

Description	Item no.
114 x 2 mm	3116-31
114 x 4 mm	3116-32
140 x 2 mm	3116-33
140 x 4 mm	3116-34
165 x 2 mm	3116-35
165 x 4 mm	3116-36

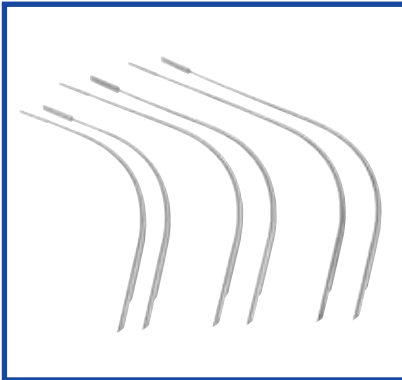

DORO® Micro Blade Set, Hooked, 6 pcs.
Item no. 3116-40

Description	Item no.
114 x 2 mm	3116-41
114 x 4 mm	3116-42
140 x 2 mm	3116-43
140 x 4 mm	3116-44
165 x 2 mm	3116-45
165 x 4 mm	3116-46

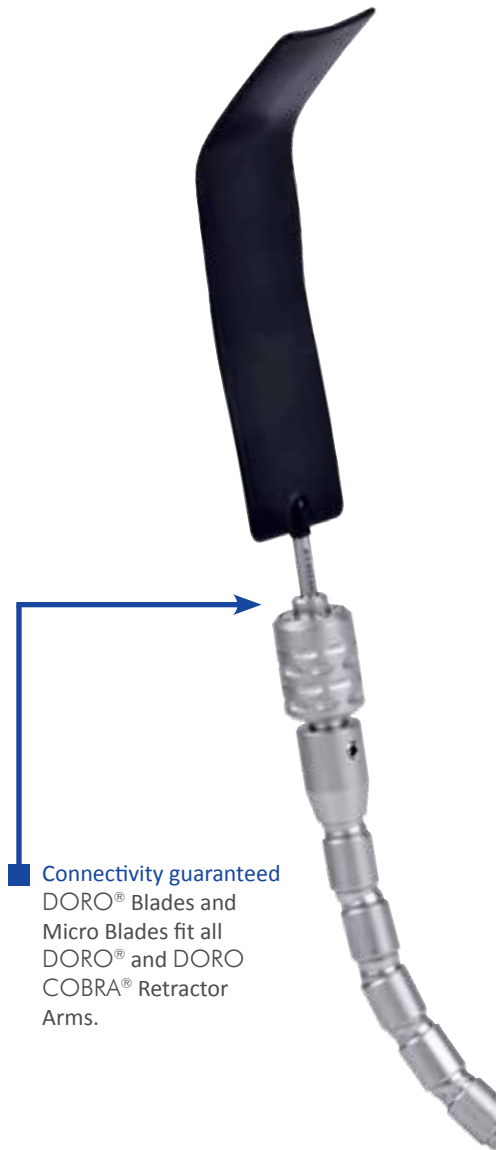

Connectivity guaranteed
DORO® Blades and Micro Blades fit all DORO® and DORO COBRA® Retractor Arms.

DORO® Sterilization Trays

DORO® Sterilization Trays

Description	Item no.
DORO® Retractor Sterilization Tray	1201.091
DORO LUNA® Sterilization Tray	1203.091
DORO® Lid for Sterilization Tray	1201.093
DORO® Halo Sterilization Case w/ Rack (shown)	3117-00
DORO® Pattie Tray Silicone Insert for Sterilization Tray	1201.092

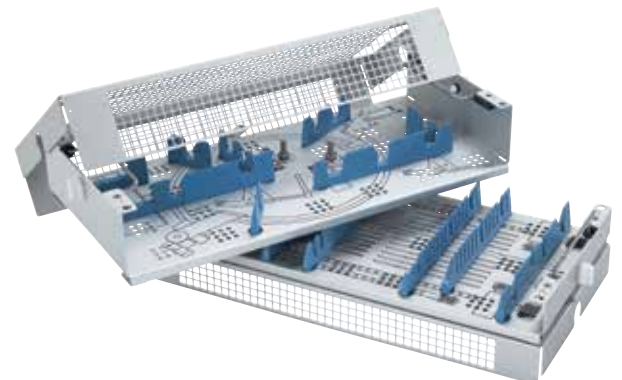

DORO®

NON-STICK Bipolar Forceps

NON-STICK
Solid noble silver tips prevent sticking and charring of tissue.

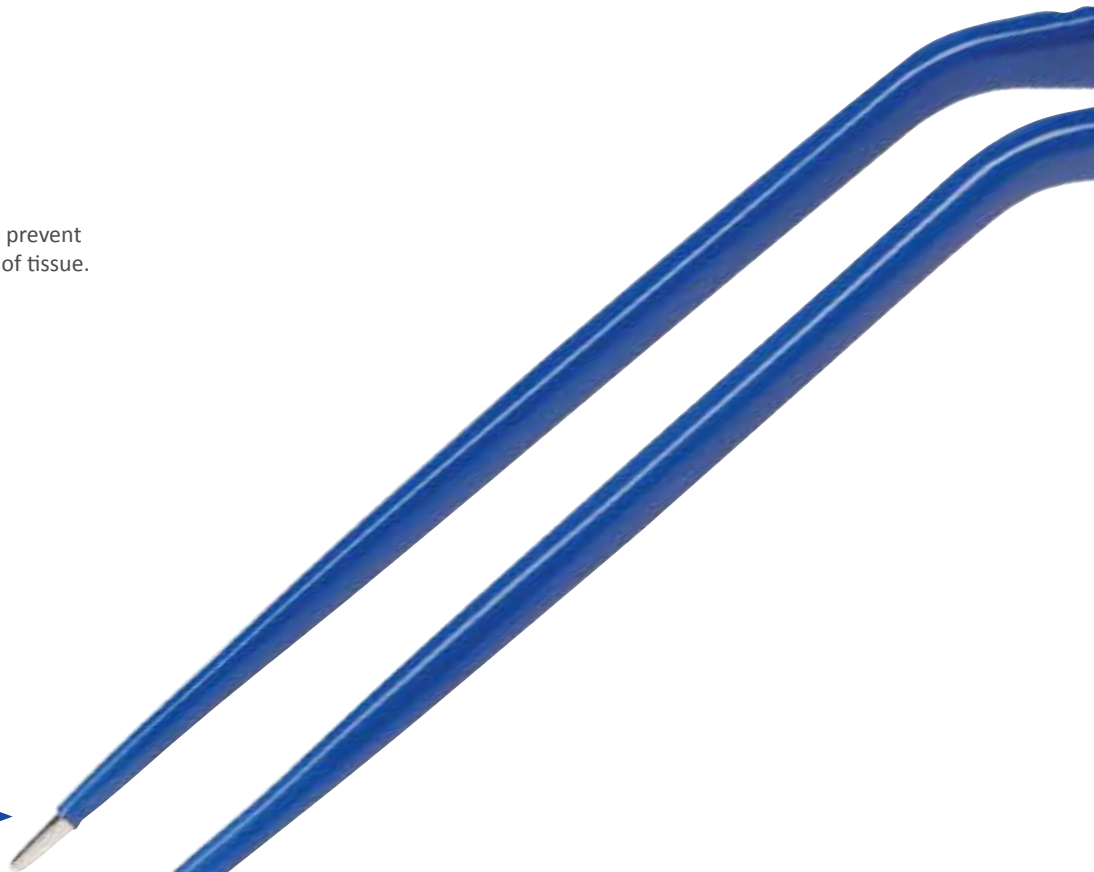

Dual tip action
design allows pinpoint coagulation for fine microsurgery or coagulation of a larger area when the forceps tips are planed together.



Adjustable Dissecting Force (ADF) provides quick adjustment of the tensile strength and the spreading dissecting force as needed for grasping, manipulating, dissecting and coagulating.

Ergonomic design for perfect balance, comfort and control.

Ask for the brochure

Headquarters Germany

pro med instruments GmbH | Bötzinger Straße 38 | 79111 Freiburg, Germany
Phone +49 761 384 222 10 | E-mail pmi@pmisurgical.com

Customer Service & Warehouse Germany

pro med instruments GmbH | Waldmatten 6 | 79224 Umkirch, Germany
Phone +49 761 384 222 11 | E-mail pmi@pmisurgical.com

US Subsidiary

pro med instruments, Inc. | 4529 S.E. 16th Place, Suite 101 | Cape Coral, FL 33904
Toll Free 877 225 4086 | E-mail pmi.us@pmisurgical.com

DORO® Representative